



URBAN DESIGN LINE
ROUND MODEL
D325MM
SUPPLY BOLLARDS

FOR DISTRIBUTION
OF ENERGY AND SERVICES

THE ROUND SUPPLY UNITS

made by New VMR S.r.l. are designed in order to deliver a sober and elegant product, suitable to be installed even in historic and city centres; infact, the functional design given to the bollards allows to Socketrve the architectural style of the sorrounding environment.

According to the top's finish, it's possible to choose between five different models:

CUT

the bollard without any top and with a flat surface

BOMBER

the bollard with a slightly round surface, like a button finish

IRIDE

the bollard with a sloping top finish

MAGNUM

the bollard with a domed top finish

PARK PARIS

the bollard with an elegant design finish and flat surface

Each round unit, made of AISI304 or AISI316L stainless steel, comes with a door and cable outlet in order to use it when closed and may come with three different diameters, that can be combined with different heights. The dimensions of these units is determined according to the equipment that has to be fitted inside.

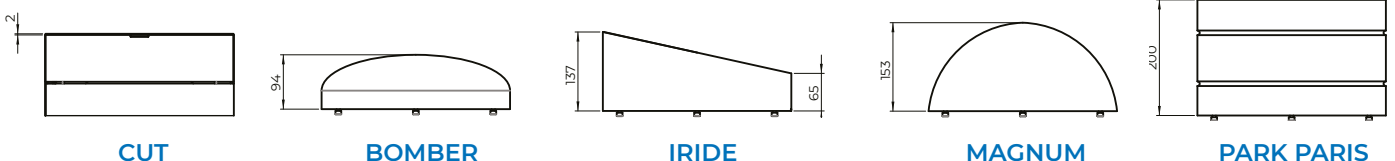

ROUND MODEL D325mm

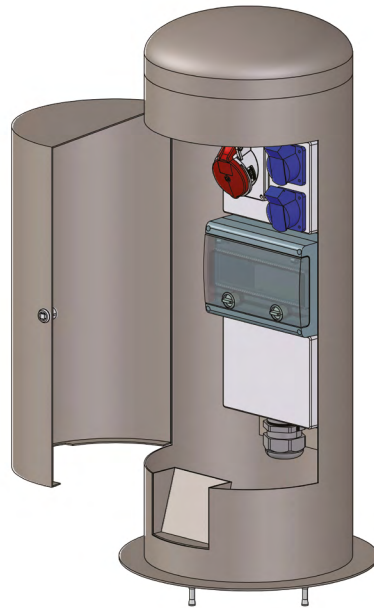

CUT



BOMBER

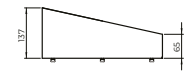

IRIDE

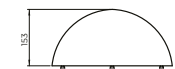

MAGNUM



PARK PARIS

MECHANICAL SPECS

Urban Technology by New VMR S.r.l. round supply unit of the Urban Design line for the distribution of energy power and services, model according to its top finish:

- CUT** without top and with flat surface
- BOMBER** with a slightly round surface, like a button finish
- IRIDE** with sloping top finish
- MAGNUM** with domed top finish
- PARK PARIS** with an elegant design finish and flat surface

entirely made of AISI304 stainless steel (AISI316L on demand and if installed in sea areas).

Completed with its door and cable outlet to use the unit even when closed. Internal fastening system and IK10 impact resistance. Painted standard colour micaceous iron grey or special RAL colour with gloss or mat finish on demand and extra charge.

Dimensions: diameter **325mm** with the height suggested by New VMR staff or the one related to a specific equipment **H860** o **H1200** o **H1350mm**.

ELECTRICAL SPECS

230V/400V tension e frequency between 50/60hz, according to regulation EN 60947-1 and EN 61439. Socket protection is standard grade IP44 (IP67 protection grade for the sockets only on demand; IP67 protection grade may need to change the dimensions of the unit). Electrical equipment containment box with IP 66 protection IEC 60 529 and CE70-1 double insulation in thermoplastic material free of halogen self-extinguishing halogen, painted gray RAL 7035 resistant to abnormal heat and fire up to 650 ° (incandescent wire test according to IEC 60 695-2 -1). Elastomer sealing gaskets for dimensional stability in continuous operation from -20 ° to + 85 °. Resistance to chemical agents (water, saline solutions, acids, bases and oils) and atmospheric agents. Reference standards: CEI 23-48 and IEC 60 670. This system is suitable for manufacturing equipment and for places with a higher risk of fire (IEC 64-8 / 7).

Technical drawing (example)

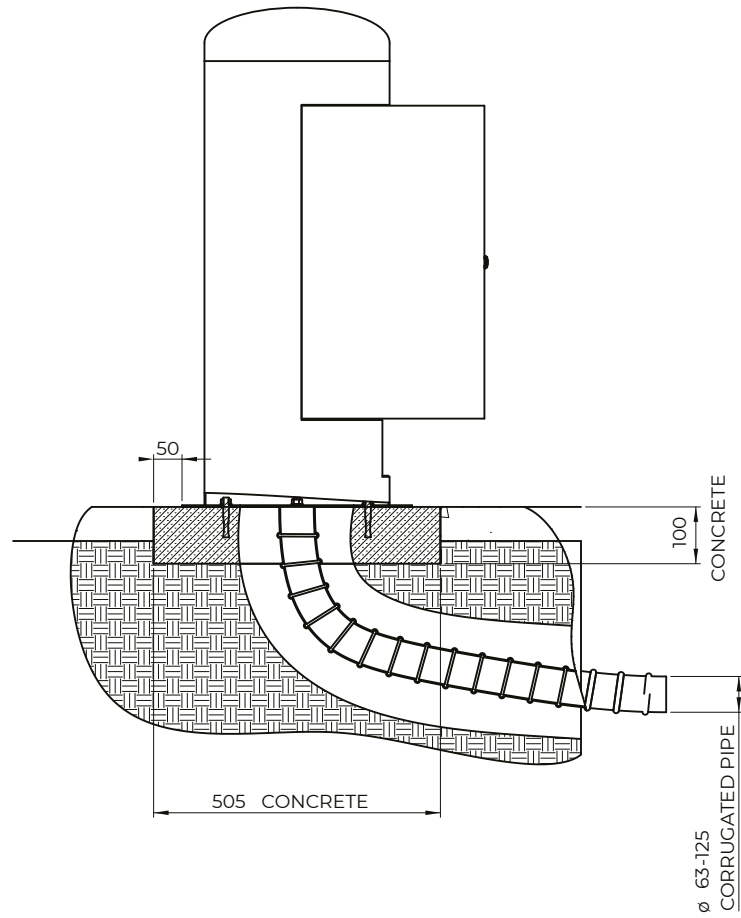
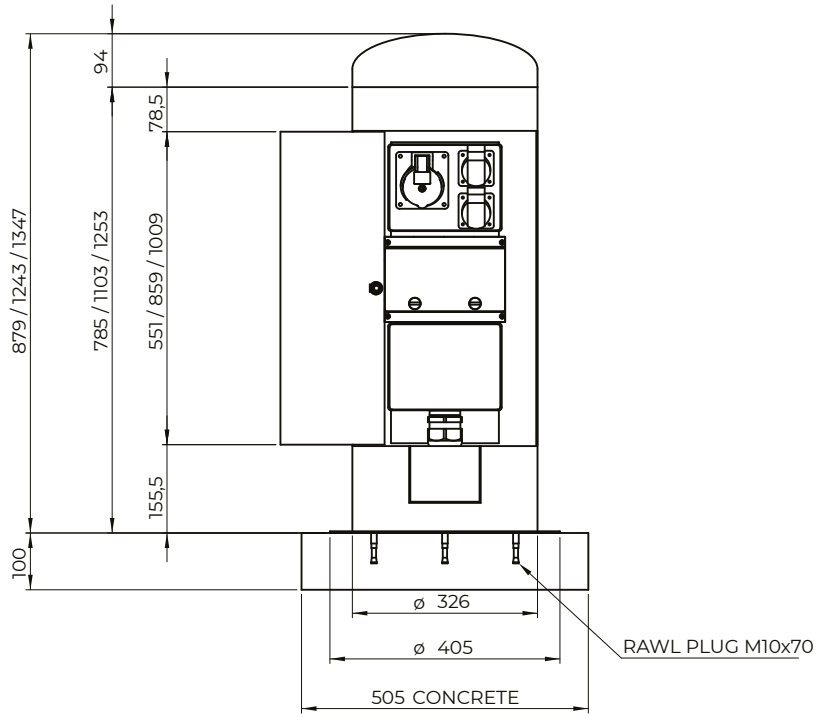

GENERAL TECHNICAL DETAILS

STRUCTURE

Impact resistance IK10

Structure made of AISI304 stainless steel

Structure made of AISI316L stainless steel for waterfronts in sea areas

CONNECTION SYSTEM

Direct connection to its terminal block

ELECTRICAL SPECS

Voltage 230V/400V

Frequency from 50hz to 60hz

Standard protection IP44 (IP67 on demand)

Regulation EN 60947-1 and EN 61439

ADDITIONAL EQUIPMENT

Wall Box for electric car and vehicle charging system

LED lighting diffusor system

Compressed air outlets

Audio / video connectors

RJ-data / video / telephone jacks

Water outlets / valves 1/2" or 3/4"

Energy consumption meters

Water consumption meters

Prepaid system with rechargeable BADGE cards

OPTIONAL ACCESSORIES

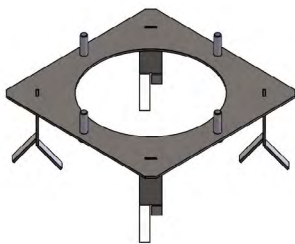

Fixing template

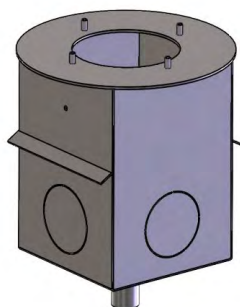

Stainless steel well with integrated fixing template

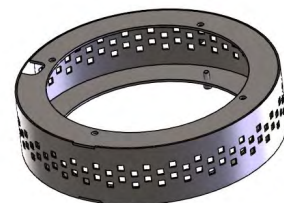

LED lighting ring

EQUIPMENTS
**D325mm
H860**

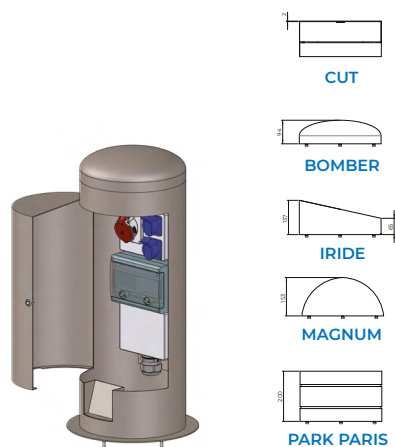

SUITABLE FOR

market areas, squares, showrooms,
parks or hotels

D325 H860 - A *

06 SCHUKO sockets
06 RCBOs 1P+N 16A 0,03 6KA

D325 H860 - B *

03 SCHUKO sockets
03 RCBOs 1P+N 16A 0,03 6KA
01 3P+N+E 16A CEE socket
01 RCBO 4x16A 0,03 6ka

D325 H860 - C *

04 2P+E 16A CEE sockets
04 RCBOs 1P+N 16A 0,03 6KA

D325 H860 - D *

02 3P+N+E 16A CEE sockets
02 RCBOs 4x16A 0,03 6ka

D325 H860 - E *

02 3P+N+E 32A CEE sockets
02 RCBOs 4x32A 0,03 6ka

D325 H860 - F *

01 3P+N+E 63A fly socket
01 RCBO 4x63A 0,03 6ka

D325 H860 - G *

02 2P+E 16A CEE sockets
02 RCBOs 1P+N 16A 0,03 6KA
01 3P+N+E 16A CEE socket
01 RCBO 4x16A 0,03 6KA

D325 H860 - H *

02 2P+E 16A CEE sockets
02 RCBOs 1P+N 16A 0,03 6KA
01 3P+N+E 32A CEE socket
01 RCBO 4x32A 0,03 6KA

OPTIONAL ACCESSORIES

- * 01 or 02 ball valves 1/2" for water or compressed air
- 01 or 02 RJ45 cat.06 data sockets
- 01 LED lighting kit
- 01 heating kit

EQUIPMENTS
**D325mm
H1200**

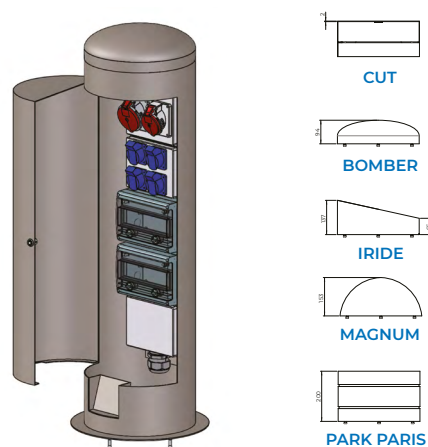

SUITABLE FOR

market areas, squares, showrooms,
parks or hotels

D325 H1200 - A *

04 SCHUKO sockets
04 RCBOs 1P+N 16A 0,03 6KA
01 3P+N+E 16A CEE socket
01 RCBO 4x16A 0,03 6ka
01 3P+N+E 32A CEE socket
01 RCBO 4x32A 0,03 6ka

D325 H1200 - B *

04 2P+E 16A CEE sockets
04 RCBOs 1P+N 16A 0,03 6KA
01 3P+N+E 16A CEE socket
01 RCBO 4x16A 0,03 6ka
01 3P+N+E 32A CEE socket
01 RCBO 4x32A 0,03 6ka

D325 H1200 - C *

02 2P+E 16A CEE sockets
02 RCBOs 1P+N 16A 0,03 6KA
02 3P+N+E 32A CEE socket
02 RCBO 4x32A 0,03 6ka

D325 H1200 - C *

08 2P+E 16A CEE sockets
08 RCBOs 1P+N 16A 0,03 6KA

OPTIONAL ACCESSORIES

- * 01 or 02 ball valves 1/2" for water or compressed air
- 01 or 02 RJ45 cat.06 data sockets
- 01 LED lighting kit
- 01 heating kit

WITHOUT EQUIPMENT- ONLY STAINLESS STEEL PLATE TO MOUNT THE EQUIPMENT

EQUIPMENTS
D325mm
H1350

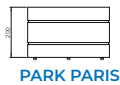
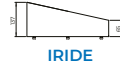
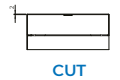

SUITABLE FOR

market areas, squares, showrooms,
 parks or hotels

D325 H1350 - A */**

06 SCHUKO sockets
06 RCBOs 1P+N 16A 0,03 6KA
01 3P+N+E 16A CEE socket
01 RCBO 4x16A 0,03 6ka
01 3P+N+E 32A CEE socket
01 RCBO 4x32A 0,03 6ka

D325 H1350 - B */**

06 2P+E 16A CEE sockets
06 RCBOs 1P+N 16A 0,03 6KA
01 3P+N+E 16A CEE socket
01 RCBO 4x16A 0,03 6ka
01 3P+N+E 32A CEE socket
01 RCBO 4x32A 0,03 6ka

D325 H1350 - C */**

04 2P+E 16A CEE sockets
04 RCBOs 1P+N 16A 0,03 6KA
02 3P+N+E 32A CEE socket
02 RCBO 4x32A 0,03 6ka

D325 H1350 - D */**

09 2P+E 16A CEE sockets
09 RCBOs 1P+N 16A 0,03 6KA

D325 H1350 - E *

04 2P+E 16A CEE sockets
04 RCBOs 1P+N 16A 0,03 6KA
01 3P+N+E 16A CEE socket
01 RCBO 4x16A 0,03 6ka
01 3P+N+E 32A CEE socket
01 RCBO 4x32A 0,03 6ka
01 3P+N+E 63A CEE fly socket
01 RCBO 4x63A 0,03 6ka

D325 H1350 - F *

04 SCHUKO sockets
04 RCBOs 1P+N 16A 0,03 6KA
01 3P+N+E 16A CEE socket
01 RCBO 4x16A 0,03 6ka
01 3P+N+E 32A CEE socket
01 RCBO 4x32A 0,03 6ka
01 3P+N+E 63A CEE fly socket
01 RCBO 4x63A 0,03 6ka

OPTIONAL ACCESSORIES

- * 01 or 02 ball valves 1/2" for water or compressed air
- 01 LED lighting kit
- 01 heating kit

- ** 01 or 02 RJ45 cat.06 data sockets

WITHOUT EQUIPMENT- ONLY STAINLESS STEEL PLATE TO MOUNT THE EQUIPMENT



WWW.VMRSRL.COM

NEW VMR S.R.L.

VIA LARIO 31, 22060 CANTÙ (CO) ITALY

+39 031 704673 | 031 7090081

INFO@VMRSRL.COM

P.IVA 03230340139